

AVTECH ELECTROSYSTEMS LTD.

NANOSECOND WAVEFORM ELECTRONICS
SINCE 1975

□ P.O. BOX 265
OGDENSBURG, NY
U.S.A. 13669-0265
TEL: (315) 472-5270
FAX: (315) 883-1328

TEL: 1-800-265-6681
FAX: 1-800-561-1970

e-mail: info@avtechpulse.com
<http://www.avtechpulse.com/>

☒ BOX 5120, LCD MERIVALE
OTTAWA, ONTARIO
CANADA K2C 3H4
TEL: (613) 226-5772
FAX: (613) 226-2802

INSTRUCTIONS

MODEL AVX-S1-INV-P1C-T1C PLUG-IN SOCKET OUTPUT MODULE

SERIAL NUMBER: 11495

"P1C" SOCKET VIEW

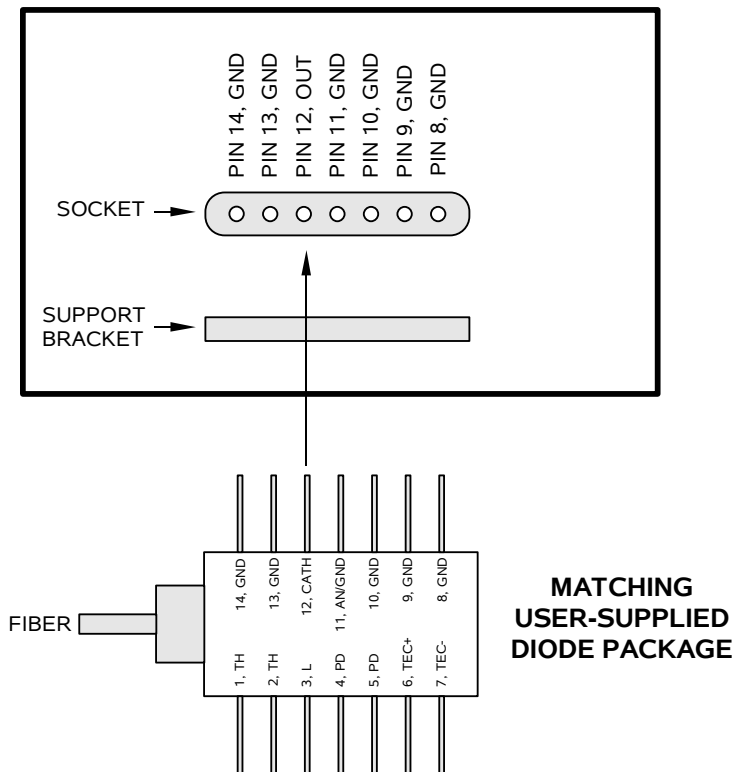

WARRANTY

Avtech Electrosystems Ltd. warrants products of its manufacture to be free from defects in material and workmanship under conditions of normal use. If, within one year after delivery to the original owner, and after prepaid return by the original owner, this Avtech product is found to be defective, Avtech shall at its option repair or replace said defective item. This warranty does not apply to units which have been disassembled, modified or subjected to conditions exceeding the applicable specifications or ratings. This warranty is the extent of the obligation assumed by Avtech with respect to this product and no other warranty or guarantee is either expressed or implied.

TECHNICAL SUPPORT

Phone: 613-226-5772 or 1-800-265-6681

Fax: 613-226-2802 or 1-800-561-1970

E-mail: info@avtechpulse.com

World Wide Web: <http://www.avtechpulse.com>

TABLE OF CONTENTS

WARRANTY.....	2
TECHNICAL SUPPORT.....	2
TABLE OF CONTENTS.....	3
INTRODUCTION.....	4
ORIGINAL QUOTATION.....	5
SPECIFICATIONS.....	6
GENERAL INFORMATION.....	7
INSTALLING THE DEVICE UNDER TEST.....	7
NORMAL TEST ARRANGEMENT.....	8
THERMAL CONTROL (-T1C UNITS).....	9
SIGNAL CONNECTORS ON THE OUTPUT MODULE.....	10
AMPLITUDE CONTROL.....	10

Manual Reference: Z:\officefiles\instructword\avx-s\AVX-S1-INV-P1C-T1C,sn11495,ed1.odt.

Last modified June 5, 2006.

Copyright © 2006 Avtech Electrosystems Ltd, All Rights Reserved.

INTRODUCTION

The AVX-S series of bias insertion units is designed to combine a pulse signal with a DC bias, and supply the resulting signal to a laser diode, which is inserted into a high quality socket included on the mount. The bias insertion module includes the necessary networks to match the laser diode to the pulse source, as well as networks for applying DC bias to the diode.

The AVX-S1-INV-P1C-T1C is specifically designed to accommodate butterfly-packaged laser diodes with the pinout illustrated below:

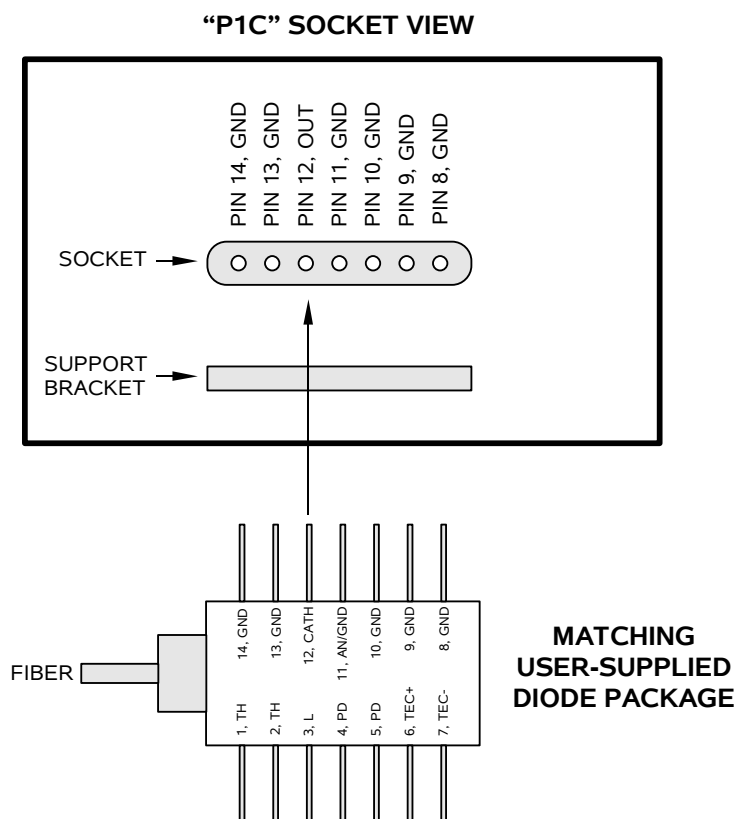

An example of a diode with the appropriate pinout is the Agere D2304G laser diode.

The AVX-S1-INV-P1C-T1C is specially designed and customized to be used with the Avtech AVP-AV-HV2-B-P (S/N 10856) pulse generator. The AVX-S1-INV-P1C-T1C includes an internal inverting transformer, so that the positive output of the AVP-AV-HV2-B-P (S/N 10856) pulse generator can be used to drive the cathode (negative side) of the Agere D2304G laser diode.

ORIGINAL QUOTATION

Date: Thu, 23 Mar 2006 11:41:04 -0500
 From: Avtech Sales
 Subject: Re: Price & Delivery Quotation

XXXXXX,

Following your recent inquiry, I am pleased to quote as follows:

Quote number: 13179

Model number: AVX-S1-INV-P1C-T1C

Description: Laser Diode Bias Insertion Unit with Socket

Suitable for Use With: The Avtech AVP-AV-HV2-B-P (S/N 10856) and the Agere D2304G laser diode.

Pricing, manuals, datasheets: <http://www.avtechpulse.com/laser-bias/avx-s1>

PDF datasheet:

http://www.avtechpulse.com/catalog/page074_cat11_avx-s_rev4.pdf

Price: \$XXXXXX US each, FOB destination (includes 5% academic discount).

Quote valid for: 60 days

Estimated delivery: 60 days after receipt of order.

Please call or email me if I can be of further assistance.

Thank you for your interest in our products!

Regards,

Mary Budarick
 Sales Manager
 MB:ql

--- Avtech Electrosystems Ltd. ----- since 1975 ---

PO Box 265	ph: 613-226-5772	Box 5120
Ogdensburg	fax: 613-226-2802	LCD Merivale
New York	email: info@avtechpulse.com	Ottawa, Ontario
USA 13669-0265	http://www.avtechpulse.com/	Canada K2C 3H4

Pulse Generators - Laser Diode Drivers - HV Amplifiers
 Monocycle Generators - Impulse Generators - Pulse Amplifiers
 Current Pulsers - Function Generators - Frequency Dividers - and more!

Free catalog & newsletter ~ <http://www.avtechpulse.com/request/>

SPECIFICATIONS

Model:	AVX-S1-INV-P1C-T1C
Peak diode current:	400 mA
Max. input amplitude:	20 Volts
Pulse width:	0.4 ¹ - 200 ns
Rise time:	0.2 ns ¹
Pulse PRF range:	DC - 25 MHz
Max. bias current:	100 mA
Max. bias voltage:	50 Volts
Input impedance:	50 Ohms
N (transformer ratio ^{2,3}):	-1
R _s + R _{DIODE} :	50 Ohms
IN connector:	SMA female (one)
Other connectors:	MV, MI, MD: SMA (female), DC bias: solder terminal
Diode socket:	-P1C option:for specific butterfly package, see footnote ⁶
Dimensions:	H x W x D: 41 mm x 66 mm x 76 mm (1.6" x 2.6" x 3.0")
Material:	Cast aluminum, blue enamel

- 1) Lower pulse widths (to 0.2 ns) and faster rise times (0.1 ns) may be possible for laser diode packages with very low parasitic inductance. The -P0 and -P2 packages generally have very low inductance. The -P1, -P3, and -TO3 packages normally have somewhat higher parasitic inductance.
- 2) The transformer reduces the input voltage by a factor of N (approx) and increases the current by a factor of N (approx). The load resistance (R_s+R_{DIODE}) must equal 50Ω / N² (approx).
- 3) A polarity inverting option is available. Add the suffix -INV to the model number to specify this option. "N" is a negative number when this option is installed.
- 4) Generic option. A drawing showing the diode package size and electrical pinout must be provided by the end-user, and the model number and price may change.
- 5) -P1B (specific pinout option). No further drawings are required. The socket will accept pins 8-14 of a standard butterfly package with 0.5 mm wide pins. A pulse will be applied to the diode anode (pin 10). Pins 8-9 and 11-13 will be grounded. Pin 14 will be made accessible through a solder terminal. Four mounting holes on a 8.9 x 26 mm grid will be provided. The diode parasitic resistance (dV/dI at lasing) must be < 1 Ohm. A low-bandwidth slide-on socket can also be provided for pins 1-7 of the diode, with the thermal control pins brought out to a standard DB-9 connector (-T1B option).
- 6) -P1C (specific pinout option). No further drawings are required. The socket will accept pins 8-14 of a standard butterfly package with 0.5 mm wide pins. A negative pulse will be applied to the diode cathode (pin 12). Pins 8-11 and 13-14 will be grounded. Four mounting holes on a 8.9 x 26 mm grid will be provided. The laser input impedance (dV/dI at lasing) must be 25 Ohms (+/- 5 Ohms). Not available on AVX-S3 models, or models with the -HC suffix. A low-bandwidth slide-on socket can also be provided for pins 1-7 of the diode, with the thermal control pins brought out to a standard DB-9 connector (-T1C option).

GENERAL INFORMATION

INSTALLING THE DEVICE UNDER TEST

The AVX-S1-INV-P1C-T1C has a “P1C” high-speed socket for pins 8-14 of the diode under test. If the “-T1C” option has been specified, a slide-on socket for pins 1-7 of the diode will also be present.

The “P1C” socket consists of seven high-bandwidth pin sockets. This socket arrangement will accept pins 8-14 of a standard butterfly package with 0.5 mm wide pins. A negative pulse will be applied to the diode cathode (pin 12). Pins 8-11 and 13-14 will be grounded. The laser input impedance (dV/dI at lasing) must be 25 Ohms (+/- 5 Ohms).

The optional “T1C” socket consists of a low-bandwidth slide-on socket board for pins 1-7 of a butterfly package. A flexible cable connects the slide-on socket to the output module. A male DB-9 connector is provided on the output module, which provides P1B access to the thermal control pins of the diode. DB-9 pin 2 connects to diode pin 1 (TH). DB-9 pin 3 connects to diode pin 2 (TH). DB-9 pin 4 connects to diode pin 6 (TEC+). DB-9 pin 5 connects to diode pin 7 (TEC-). The remaining DB-9 pins are unconnected. Pins 4 and 5 of the diode are grounded. Pin 3 is unconnected. Access to the photodiode, if present, is not provided. This option is designed for compatibility with Thorlabs temperature controllers and certain QPhotonics laser diodes. It may be suitable for others as well.

With no diode installed, the output module will look similar to this:

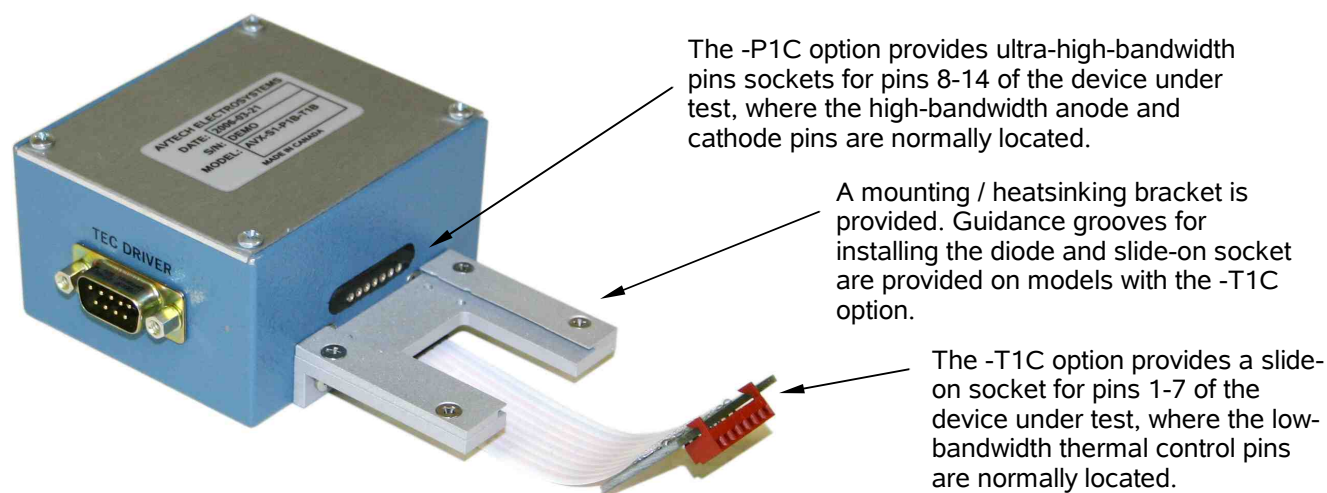

The diode is first installed by sliding pins 8-14 into the “P1C” pin sockets, as shown below:

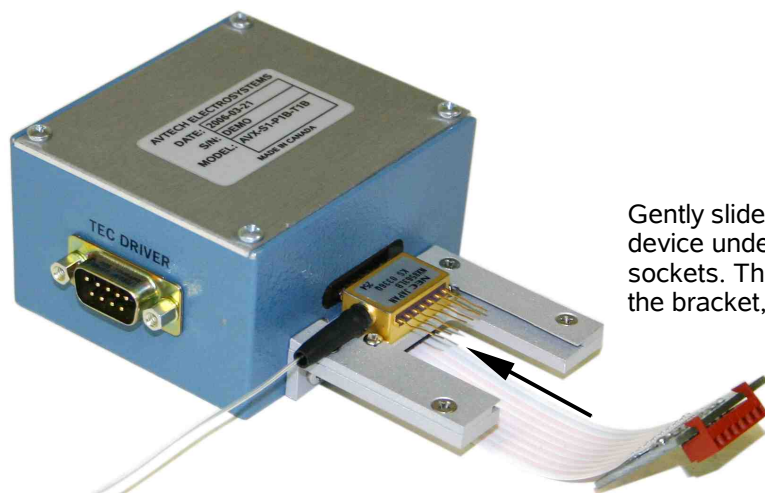

Gently slide the high-bandwidth side of the device under test into the matching pin sockets. The device can be screwed down to the bracket, if desired.

If present, the T1C slide-on socket assembly can then be slid onto pins 1-7, as shown below:

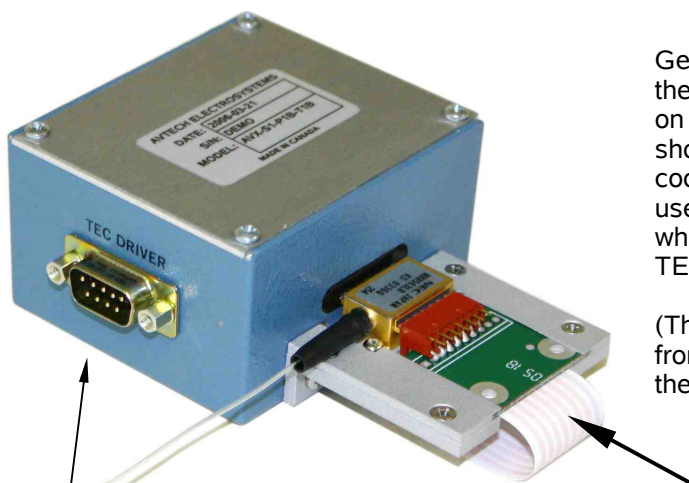

Gently slide the low-bandwidth slide-on socket onto the matching pins of the device under test. The slide-on socket is connected to the output module using a short length of flexible ribbon cable. The thermoelectric cooler and thermistor pins are made accessible to the user through the "TEC DRIVER" DB-9 connector, which will mate to cables from common third-party TEC controllers.

(The SMA connectors which connect to the cabling from the mainframe are on the module side opposite the pin socket. They are not visible in these photos.)

To optional third-party TEC controller.

NORMAL TEST ARRANGEMENT

To fully test the instrument, and for normal operation, the output module must be connected as shown below:

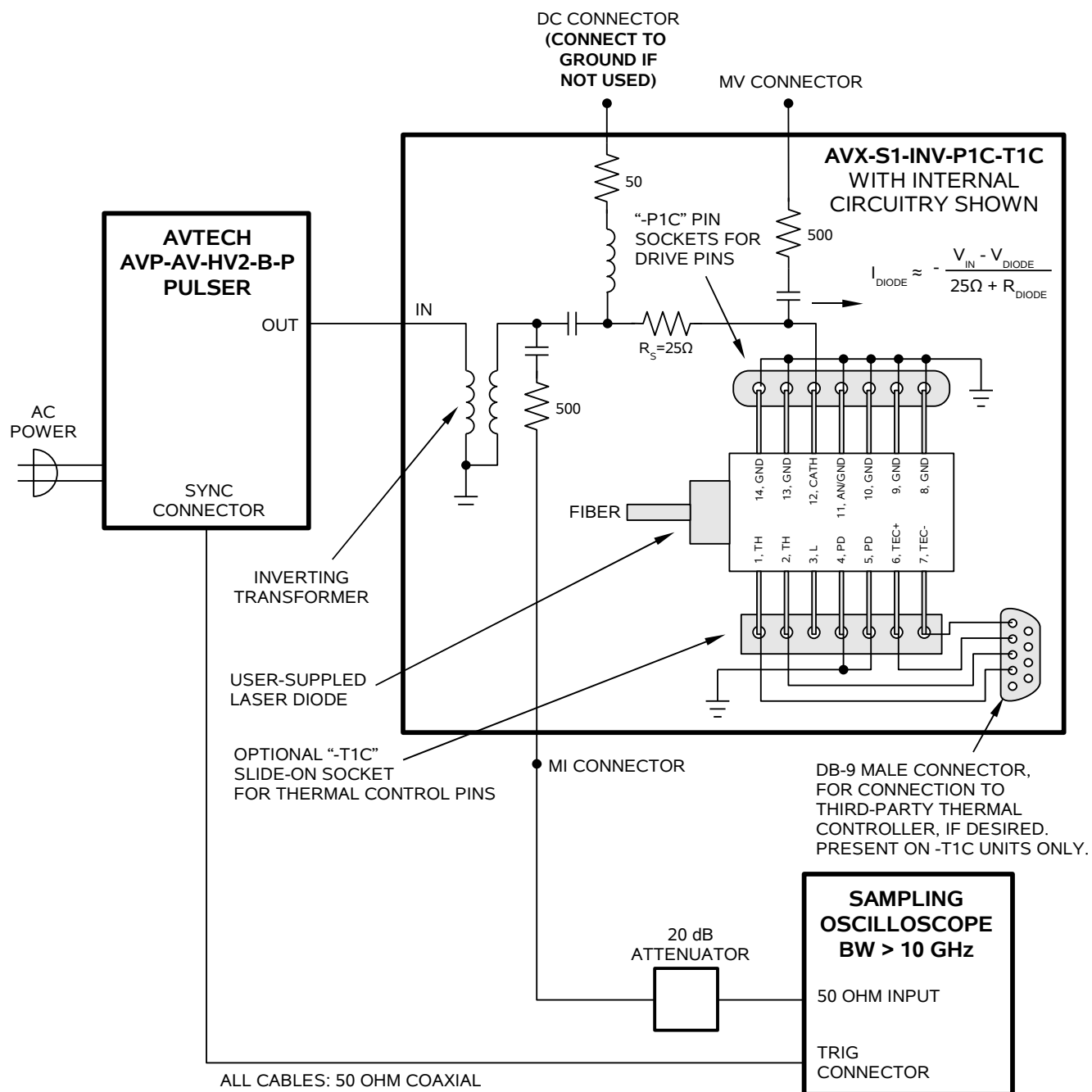

THERMAL CONTROL (-T1C UNITS)

Models with the "-T1C" option include a DB-9 male connector that will mate to third-party temperature controllers. These third-party controllers provide a means of controlling the thermoelectric cooler that is typically present in butterfly-packaged laser diodes, if desired. The need for cooling is dependent on the user's application. Cooling is generally recommended by device manufacturers.

SIGNAL CONNECTORS ON THE OUTPUT MODULE

An oscilloscope may be used to monitor the MI and MV outputs. A forward DC bias may be applied to the laser diode by connecting a DC potential of 0 to -10 Volts to the DC solder terminal. The application of a small forward bias often yields a more ideal diode current waveform (as observed on the MI port).

 Note that the DC port must be shorted to ground if a bias is not applied. Waveform distortions will occur otherwise.

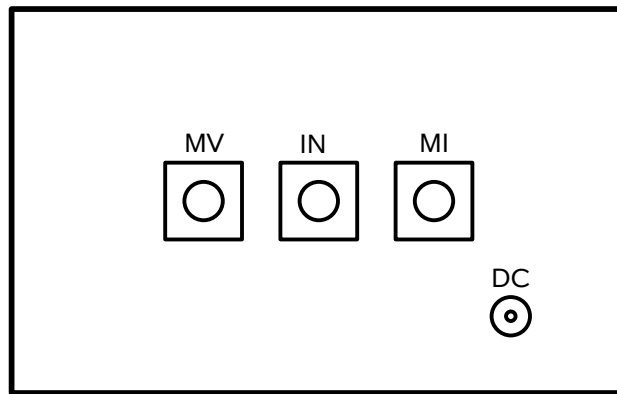

AVX-S1-P1C OUTPUT MODULE, CONNECTOR VIEW

AMPLITUDE CONTROL

When using the AVX-S1-INV-P1C-T1C with the AVP-AV-HV2-B-P, the pulse current through the diode load is given by:

$$I_{\text{DIODE}} = - (V_{\text{SET}} - V_{\text{DIODE}}) / (25\Omega + R_{\text{DIODE}})$$

where V_{SET} is the amplitude setting on the AVP-AV-HV2-B-P (between 0 and +20V), V_{DIODE} is the forward voltage drop across the diode (up to 3V), and R_{DIODE} is the resistor internal to the laser diode (typically 20 Ω to 30 Ω). The 25 Ω resistance is built into the AVX-S1-P1C output module.

For optimal results, the laser diode resistance should be 25 Ω , so that $25\Omega + R_{\text{DIODE}} = 50\Omega$, resulting in a proper transmission line match for the 50 Ω coaxial cabling. However, laser diode resistances in the range of 20 Ω to 30 Ω will provide good results with minimal distortion.